

PCB BOILER SETTING TYPE HAGC03 BX01

SERVICE instruction

Contents

1. Parameters setting	3
2. Anomalies diagnostic	11
2.1 Diagnostic anomaly display	12
2.2 Anomalies table for the installer.....	13
3. Relay card connection	17
3.1 RELAYS 1 / 2 - P04 / P05 PARAMETERS SETTING.....	18
3.2 CN2 RELAY CARD CONNECTOR (Programmable input-parameter P07)	18
3.3 Programmable input-parameter P06	19
3.4 P06 and P07 -PARAMETER SETTING DESCRIPTION.....	19
4. Calibration function	20
----- IMPORTANT NOTE -----.....	21
5. PCB spare	21
6. PCB Spare with easy key service	22
7.CO2 adjustment	24
8. General spares	25
9. Manual Control function (301)	25
10. Commissioning Function flow chart	26
11. Pressure table	28
12. Installation with flue duct Ø 50 mm	29

1. Parameters setting

To set the PCB parameters proceed as follows:

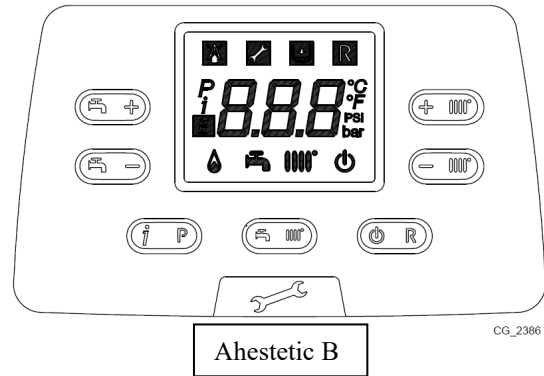
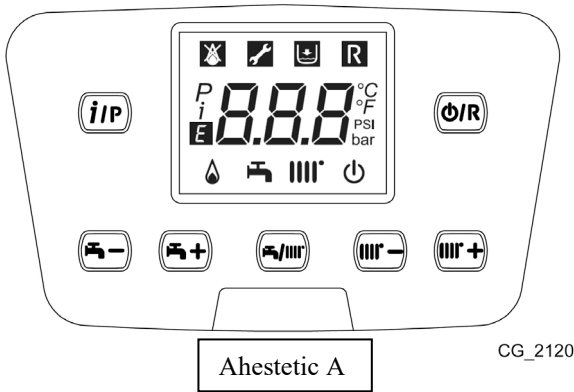

To set the parameters proceed as follows:

- 1) Press together for about 6 seconds the and buttons, the display shows “**P01**” alternating with its value (**01**);
- 2) Press the and buttons to scroll the parameters list;
- 3) Press the button to edit the selected parameter;
- 4) Press the and buttons to modify the parameter value ;
- 5) Press the button to save the parameter value and return at the parameter list or press the button to exit without saving and return at the parameter list;
- 6) Press the button again to exit the function without saving.

*In the default condition it is possible to scroll the parameters until **P42**. If you need to set some parameters after **P42** proceed in the following way:*

- Press the and buttons until **P22**;
- Press the button to edit the selected parameter;
- Set **P22 = 22**;
- Press the button to save the parameter value;
- Press the and buttons to scroll the parameters from **P42** to last parameter

DEFAULT PARAMETERS		LUNA DUOTEC / IN										DUO TEC MAX		NUVOLA BOILER CONDENS			
PXX	Parameters description	1.12	1.24	1.28	1.32	20/24	20/24 (2+1)	20/20	20/20 (2+1)	24/28	28/33	32/40	20/24	28/33	12/16	20/24	28/33
01	DHW modulation 00 = standard 01 = fast	01															
02	Gas type 00= natural gas 01= LPG	00 / 01															
03	Boiler setting 00= instantaneous combi boiler 01= instantaneous combi boiler with DHW micro tank 03= instantaneous combi boiler with pre heat 04 = only heating boiler with DHW thermostat (system boiler 1) 05= only heating boiler for external DHW tank 06= boiler with DHW storage tank 07 = Heating only 08 = only heating boiler 09 = storage tank 3 (simple solar) 10 = instantaneous boiler for solar application 11 = instantaneous boiler for solar application with DHW micro-tank 13 = instantaneous boiler with pre-heat for solar application 15= only heating boiler with DHW pump for external tank 16= boiler with DHW storage tank and DHW pump with plate to plate DHW heat exchanger 17 = System boiler 2 (04 without pump) 18 = only heating boiler with DHW pump for external tank 19 = System boiler 3	08				00				01		06					
04	Programmable Relay 1 setting 00= no function is associated 01= close contact with a room thermostat request (230V~) 02= close contact with a remote control request 03= relay for water filling system 04 = relay for display anomaly 05 = relay for kitchen fan function 07 = relay for postcirculation pump	02															

DEFAULT PARAMETERS		LUNA DUOTEC / IN										DUO TEC MAX		NUVOLA BOILER CONDENS			
PXX	Parameters description	1.12	1.24	1.28	1.32	20/24	20/24 (2+1)	20/20	20/20 (2+1)	24/28	28/33	32/40	20/24	28/33	12/16	20/24	28/33
	08 = relay for temporary DHW external pump 09 = DHW relay on with HWPR =1 10= DHW relay on with DHW request; if P64 = 1 relay on with CH request 13 = relay for Cooling function 14= close contact with a room thermostat request (230V~) with postcirculation 15= close contact with a remote control request with postcirculation																
05	Programmable Relay 2 setting The same configurations as Relay 1																04 (03 for in wall model)
06	External sensor programmable input setting 00= with an external sensor connected, the external temperature value has influence to calculate the heating flow temperature setpoint 01= with an external sensor connected, the display shows the external temperature value (no influence) 02= no function is associated 03= heating request input (e.g. telephonic trigger) 04 = Low temperature safety thermostat 05 = DHW pump activation																00
07	00= no function 03= heating request input (e.g. telephonic trigger) 04 = Low temperature safety thermostat 05 = DHW pump activation																00
08	DHW sensor setting 00= sensor connected 01= without sensor																00
09	Hydraulic component setting 00= Turbine flux Meter (Bitron COMPOSITE) 01= flow switch (Fugas BRASS) 02 = flow switch																00 / 01

DEFAULT PARAMETERS		LUNA DUOTEC / IN										DUO TEC MAX		NUVOLA BOILER CONDENS			
PXX	Parameters description	1.12	1.24	1.28	1.32	20/24	20/24 (2+1)	20/20	20/20 (2+1)	24/28	28/33	32/40	20/24	28/33	12/16	20/24	28/33
10	Heating setpoint setting OT / RT (Open Therm / Room Thermostat 230V~) 00= with Remote Control (RC) connected, the temperature request is the RC setpoint 01= The temperature Request is the highest set point between RC and PCB 02 = The temperature request is the RC setpoint. The RT enable the gas boiler operates. 03 = The temperature Request is the highest set point between RC and PCB if the request are both, else the set point are independent.																
11	2 speed pump enable / disable 00: Enabled at high speed 01: Enabled at low speed 02: Disabled (automatic speed)																
12	WPM test enable / disable 00: Disabled 01: Enabled																
13	Maximum CH output (%)		100				80			86	80	77	80	80	77	80	80
14	Maximum DHW output (%)			100				80									100
15	Minimum DHW output (%)																
16	Maximum Central Heating setpoint (°C) 00= 85°C 01= 45°C																
17	Pump overrun time in heating mode (min)																
18	Maximum overrun time before a new relight of burner in heating mode (min)																
19	Kick pump time (min)																
20	DHW postcirculation (0...255 sec)																
21	Anti-Legionella function 00= disabled 55...67 = enabled (setpoint value °C)																
22	Display parameters from P42 to P76																
23	Maximum DHW setpoint (°C) (55°C ...65°C)																
24	DHW delay time request with turbine flow																

DEFAULT PARAMETERS		LUNA DUOTEC / IN										DUO TEC MAX		NUVOLA BOILER CONDENS			
PXX	Parameters description	1.12	1.24	1.28	1.32	20/24	20/24 (2+1)	20/20	20/20 (2+1)	24/28	28/33	32/40	20/24	28/33	12/16	20/24	28/33
	switch (default=20ms)																
25	Lack of water safety device 00= water pressure switch 01= differential water pressure switch 02 = water pressure switch ON/OFF																00 (02 for Compact model)
26	Manufacture information																/
27	Manufacture information																/
28	Manufacture information																/
29	Manufacture information																/
30	DHW Offset setting 0...15°C (only with P03=06)																00
31	Remote control minimum temperature setpoint (°C)																25
32	Display the anomaly historian 0																/
33	Display the anomaly historian 1																/
34	Display the anomaly historian 2																/
35	Display the anomaly historian 3																/
36	Display the anomaly historian 4																/
37	Display the anomaly historian 5																/
38	Display the anomaly historian 6																/
39	Display the anomaly historian 7																/
40	Display the anomaly historian 8																/
41	Display the anomaly historian 9																/
42	Enable / Disable Gradient Control on the flow temperature																00
43	Mains frequency selection 0 = 50 Hz (Europe) 1 = 60Hz (Canada)																00
44	Temperature unit setting 0 = °C 1 = °F 2 = no noise °C 3 = no noise °F																00
45	Manufacture information																01

DEFAULT PARAMETERS		LUNA DUOTEC / IN										DUO TEC MAX		NUVOLA BOILER CONDENS				
PXX	Parameters description	1.12	1.24	1.28	1.32	20/24	20/24 (2+1)	20/20	20/20 (2+1)	24/28	28/33	32/40	20/24	28/33	12/16	20/24	28/33	
46	Manufacture information																	63
47	Min PWM pump																	80
48	Manufacture information																	01
49	Manufacture information																	50
50	Manufacture information																	00
51	CH Offset set point in DHW (only with P03 = 05 – 08 – 15 - 18)																	25
52	Flow temperature OFF value in DHW (only with P03 = 05 – 08 – 15 - 18)																	90
53	CH Offset (only with P03=06-16)																	00
54	K boost storage tank regulation (only with P03 = 06 - 16)																	20
55	Junction function storage tank regulation enable / disable (only with P03 = 06 - 16) 0 = Enabled 1 = Disabled																	00
56	DHW frost protection enable / disable 0 = Enabled 1 = Disabled																	00
57	Manufacture information																	30
58	Manufacture information																	05
59	Manufacture information																	00
60	Manufacture information																	00
61	LTU_36 counter max value																	36
62	LTU_36 counter reload value after daily reset																	09
63	Pump activation delay after 3WV (only with P03 = 05 -06 – 08)																	08
64	Aux relay activation with DHW request (with P04-05 = 10) 0 = on with DHW request 1 = DHW and CH request																	00
65	Intelligent preheat forward time setting																	00
66	Manufacture information																	98
67	OT selection																	00

DEFAULT PARAMETERS		LUNA DUOTEC / IN											DUO TEC MAX		NUVOLA BOILER CONDENS			
PXX	Parameters description	1.12	1.24	1.28	1.32	20/24	20/24 (2+1)	20/20	20/20 (2+1)	24/28	28/33	32/40	20/24	28/33	12/16	20/24	28/33	
	0 = Plug&Play 1 = OT B&P 2 = OT STD																	
68	DHW request delay (0...60s)	00																
69	Special configuration 0...4 = no function is associated 5 = relay activation for P19 minutes (P19/2 in summer selection)	0																
70	Ignition fan speed setting Fan speed = P70 * 100 rpm	45	35	35	35	35	30	35	30	35	35	38	35	35	35	35	35	
71	***Maximum fan speed Fan Speed = 5000 + P71 * 10 rpm	30	100	120	35	100	115	100	115	185	180	170	100	180	80	100	180	
72	Minimum fan speed Fan speed = 750 + P72 * 10 rpm	45	35	35	25	35	42	35	42	40	40	35	35	40	35	35	40	
73	Power selection	4	11	9	10	7	0	7	0	1	2	3	7	2	19	7	2	
74	Ignition delay (for HO)	00																
75	Production Information	---																
76	Aesthetic A = 0 B = 1	00													0	1	0	1
77	Visualization sw and hw type 0 = sw version 1 = sw version and hw version	00																
78	0...10V selection input 0 = disabled 1 = Set point Modulating: 3V min set point CH and 10V max set point CH 2 = Power Modulating: 3V min power and 10V max CH power with set point fixed by HMI	00																
79	Switch off DHW selection delta 0 = switch off @ 67°C fixed 1...15 = Delta switch off from set point	00																

DEFAULT PARAMETERS		LUNA DUOTEC / IN										DUO TEC MAX		NUVOLA BOILER CONDENS			
PXX	Parameters description	1.12	1.24	1.28	1.32	20/24	20/24 (2+1)	20/20	20/20 (2+1)	24/28	28/33	32/40	20/24	28/33	12/16	20/24	28/33
80	Input selection MFF1 0 = Termofuse 1 = NTC flue sensor 2..4 = free																00
81	Input selection MFF2 0 = Termofuse 1 = NTC flue sensor 2 = condensate alarm 3..4 = free																00
82	Input selection MFF3 0 = Termofuse 1 = NTC flue sensor 2 = condensate alarm 3= 0..10V 4 = free																00
83	Minimum CH set point (20...60°C)																25

***Maximum fan speed Fan Speed = **5000** + P71 * 10 rpm

For models: 15 kW and 18kW the rule is: Maximum fan speed Fan Speed = **4500** + P71 * 10 rpm

P70 Ignition fan speed setting Fan speed = P70 * 100 rpm
P71 Maximum fan speed Fan Speed = 5000 + P71 * 10 rpm
P72 Minimum fan speed Fan speed = 750 + P72 * 10 rpm

Example

To set ignition speed at 3000 rpm P70 = 30

To set max fan speed at 5800 rpm P71 = 80

To set min fan speed at 1100 rpm P72 = 35

2. Anomalies diagnostic

The LUNA 4 PCB allows to display the last 10 anomalies occurred in the appliance. PCB has a counter which increases itself only if the happened anomaly is consecutive and the same. Not consecutive anomalies don't increase the counter.

To display all the information for each anomaly, proceed as described in section 1 and scroll the list until P32 parameter.

Parameters from P32 to P38 (C00 to C06) are refer to anomalies which don't need to be reset (e.g. DHW sensor fault);

Parameters from P39 to P41 (C07 to C09) are refer to anomalies which required to be reset (e.g. safety thermostat).

PCB has another counter which allows to display how long ago the anomaly is happened. The range of this counter is from 0 (the day in which the anomaly happen) to 99 (up to 3 month ago).

E.g. : 45 indicates that the anomaly is happened one month and half ago.

The historian anomalies of each parameters (**Pxx** – see the anomalies table) are displayed in the following order:

- anomaly number (C00 is the la test anomaly)
- anomaly code
- consecutive counter for the same anomaly
- number of days elapsed from the anomaly event
- system status
- phase status
- CH flow temperature value during the anomaly event

See the following table for the anomaly codes

The **system status** is the operating mode before the anomaly

01	Stand-by
02	DHW request
03	Controller stop function active
04	CH request
05	Preheat function active
06	CH frost protection function active
07	DHW frost protection function active
08	Post-circulation pump active
09	Overheating circulation pump function active

The **phase status** is a special operating mode before the anomaly

- 00** Stand-by
- 01** Pre-purging function active
- 03** Ignition load purging between the first attempt and the second one
- 04** Ignition load first attempt
- 05** Operation active
- 06** Lock out
- 08** Second ignition load attempt
- 11** Ignition load purging between the second attempt and the third one
- 14** Third ignition load attempt
- 15** Post-purging function
- 16** Overheating post-purging function active

Diagnostic is carries out to the display in a different way.
It depends on the type of PCB used, as described in the following table:

2.1 Diagnostic anomaly display

C00
E133
=02
000
03
F05
75°C
In the event of no anomaly, the historian anomalies values are = 00

It is possible also to verify the internal code of the error (see anomalies table) pressing the Info button at least 1 second.

The internal code is showing only if the anomaly is present on the display.

Ex: if the display shows E125, pressing the Info button the internal code 500 or 501 or 502 is displayed.

2.2 Anomalies table for the installer

Use this table to report the anomaly values.

		ANOMALY NUMBER	ANOMALY CODE	CONSECUTIVE COUNTER FOR THE SAME ANOMALY	NUMBER OF DAYS ELAPSED FROM THE ANOMALY EVENT	SYSTEM STATUS	PHASE STATUS	CH FLOW TEMPERATURE VALUE DURING THE ANOMALY EVENT
NO RESET ANOMALY	P32	C00						
	P33	C01						
	P34	C02						
	P35	C03						
	P36	C04						
	P37	C05						
	P38	C06						
RESET ANOMALY	P39	C07						
	P40	C08						
	P41	C09						

ANOMALY CODE	INTERNAL CODE	ANOMALY	ACTION
E09		Gas valve connection fault	Check the cable pcb/gas valve and gas valve plug
E10		External probe fault	Check the sensor
E11		External RF probe fault	Check the sensor
E12		Differential water flow switch fault (still open)	Check the water flow switch
E13		Differential water flow switch (still close)	Check the water flow switch
E15		Gas valve comand fault	Check the cable pcb/gas valve, replace pcb if it necessary
E18		Water refill activated	Function active message
E19		Maximum time of water refill	Check the refill hydraulic
E20	1	Central heating NTC sensor fault (s.c.)	Check the sensor
E20	2	Central heating NTC sensor fault (o.c.)	Check the sensor
E40	1	Return central heating NTC sensor fault (s.c.)	Check the sensor
E40	2	Return central heating NTC sensor fault (o.c.)	Check the sensor
E28	539	Flue NTC sensor fault (s.c.)	Check the sensor
E28	540	Flue NTC sensor fault (o.c.)	Check the sensor
E50	1	DHW NTC sensor fault (tank boiler) (s.c.)	Check the sensor
E50	2	DHW NTC sensor fault (tank boiler) (o.c.)	Check the sensor
E53		Obstruction on the flue pipe	Check obstruction on the flue pipe Within 10 min E53 is volatile, after it is lockout (remove the power supply)
E55		PCB to be set by the "Calibration Function"	Enable the Calibration function
E71		Fan parametr Out of range in autocalibration	Check the fan speed
E72		Combustion test Out of range in autocalibration	Check the correct position and integrity of the sensing electrode, and the cable
E77		Current out of range	Check the correct position and integrity of the sensing electrode, flue recirculation, enable the automatic calibration function before to replace components.
E78		Minimum gas valve current	Check the gas supply pressure, the correct position and integrity of the sensing electrode, flue recirculation, CO2 value in ignition, enable the automatic calibration function before to replace components.
E79		Maximum gas valve current	Check the correct position and integrity of the sensing

			electrode, flue recirculation, enable the automatic calibration function before to replace components.
E83/84/85/86/87		No communication	Check cable between room unit and pcb or RF link.
E92		Combustion test alarm during auto-setting	Check flue recirculation
E109		Precirculation alarm	Check the correct circulation of the water and the pump
E110	437	Boiler max temperature exceeded for gradient (probable pump jammed or air in the circuit)	Check the correct circulation of the water and the pump
E110	438	Boiler max temperature exceeded for overtemperature	Check the correct circulation of the water and the pump (probable pump jammed or air in the circuit)
E110		Safety thermostat sensor tripped	Check the sensor
E117	566	Water pressure HIGH (> 2.9 bar)	Check the water pressure
E118		Water pressure LOW (< 0.5 bar)	Check the water pressure
E125	500	Water circulation fault (overtemperature)	Check the correct circulation of the water and the pump
E125	501	Water circulation fault (flatness on the flow)	Check the correct circulation of the water and the pump
E125	502	Water circulation fault (flatness on the return)	Check the correct circulation of the water and the pump
E127		Antilegionella temperature not reached	Check the tank system and DHW NTC sensor
E128		Safety error for frequently loss of flame	Check the sensing electrode and the cable, flue recirculation, enable the automatic calibration function before to replace components..
E129		Safety error for frequently loss of flame with max correction during the ignition	Check the sensing electrode and the cable, flue recirculation, enable the automatic calibration function before to replace components..
E130	528	Flue thermostat sensor tripped (lockout)	Check the thermostat, the correct circulation of the water and the pump. Check the status of the primary exchanger
E133	0	Gas supply fault (no ignition)	Check the power supply, sensing electrode, spark electrode and cable. Check flue recirculation, enable the automatic calibration function before to replace components.
E133	1	No ignition (frozen / obstruction condensate trap)	Check the correct operation of the condensate trap
E134		Elapsed time gas valve open without gas (short request in a short period)	Check the gas pressure, sensing electrode, spark electrode and cable, replace the pcb if it necessary
E135		Internal error	Replace pcb

E135		Gas valve connection fault	Check the cable pcb/gas valve and gas valve plug
E154		Plausibility test (flow/return)	Check the correct circulation of the water and the pump, check the correct position of the sensors
E160		Fan fault	Check the fan and the cable
E178		Low temperature safety thermostat	Check the sensor and the correct circulation of the water and the pump
E270/161		Dry fire or overheat prevention	Check the sensor and the correct circulation of the water and the pump
E317/162		Wrong power supply electrical frequency (Hz)	Check the frequency (Hz) and the power supply
E321/163	1	Domestic Hot Water NTC sensor fault (s.c.)	Check the sensor
E321/163	2	Domestic Hot Water NTC sensor fault (o.c.)	Check the sensor
E384/164		Fault flame (parasitic flame)	Verify if the condensate trap is clean. Check the correct operation of the gas valve, humidity on the pcb and on the detection electrode
E385/165		Under voltage	Check the power supply (V~)
E430/166	557	Water pressure temporary test	Check the correct circulation of the water and the pump
E430 + flame crossed/166	505	Water pressure test failed	Check the correct circulation of the water and the pump
E431/167	1	Aluminium sensor fault (s.c.)	Check the sensor
E431/167	2	Aluminium sensor fault (o.c.)	Check the sensor

Anomalies only in the fault history

E62		Antiwind activation with increase of the minimum fan speed	Check the position of the terminal of the flue duct. No other action to do
E63/E65		Combustion level out of range	Check flue recirculation and the combustion levels.
E65		Maximum value of the speed reached/ correction of the flame signal	Check flue recirculation and the combustion levels.
E66		Obstruction of the flue duct at minimum power	Check obstruction on the flue duct.
E67		Antiwind activation at maximum power	Check the position of the terminal of the flue duct.
E68		Instability of gas pressure	Check the pressure of gas supply
E69		Combustion level out of range	Check flue recirculation and the combustion levels.
E70		Flame signal problem/micro interruption of the flame signal	Check cable and integrity of the sensing electrode, verify the continuity between burner and earth.
E73		Modified Flame signal	No action to do

3. Relay card connection

A relay card with programmable outputs (supplied as an accessory), can be connected to PCB

Relays outputs are setting by **P04** (relay 1) and **P05** (relay 2) parameters.

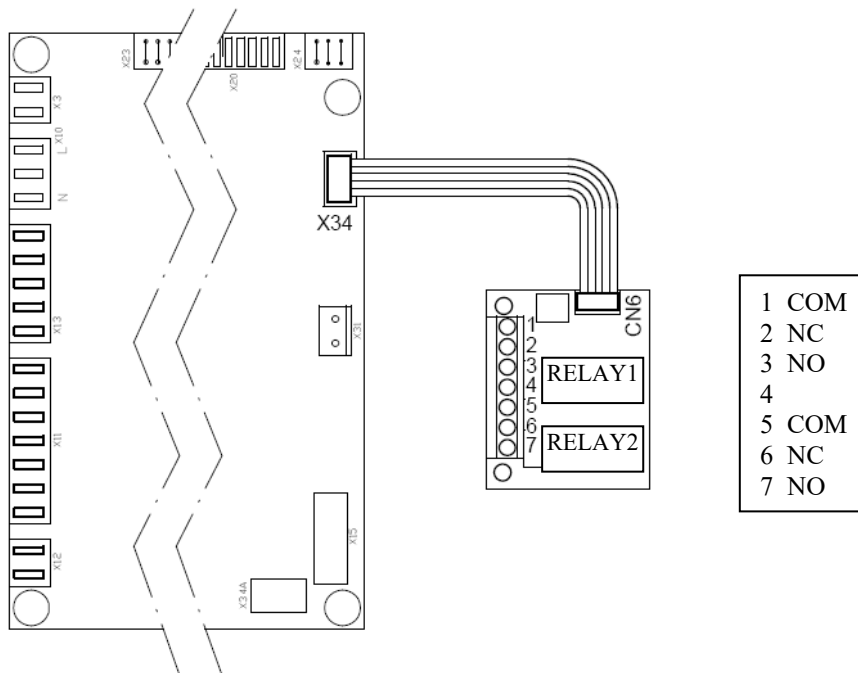

Each relay output are activated as follows:

- 00** Not used
- 01** RT 230V (Room Thermostat) request
- 02** Low Voltage RT or OT (Open Therm) request
- 03** Water filling request
- 04** Anomalies
- 05** Fan operates
- 06** Not used
- 07** CH or DHW request
- 08** DHW external pump temporary activated
- 09** DHW external pump temporary activated with a remote control DHW Time Switch Program
- 10** DHW request
- 11** Not used
- 12** Not used
- 13** Cool function
- 14** RT 230V (Room Thermostat) request included postcirculation pump
- 15** Low Voltage RT or OT (Open Therm) request included postcirculation pump

Default parameters are: **P04 = 02** and **P05 = 04**.

3.1 RELAYS 1 / 2 - P04 / P05 PARAMETERS SETTING

- 00** Not used
- 01** Output is activated during a 230 V RT request (M1 terminal block contacts).
- 02** Output is activated during a Low Voltage RT or OT request (M2 terminal block contacts).
- 03** During a water pressure switch request, the relay output is activated.
- 04** In the event any anomalies occurs the relay output is activated.
- 05** For each fan operate the relay output is activated.
- 06** Not used
- 07** For each CH or DHW request, the relay output is activated.
- 08** The contact is closed for a time set by P19 (default = 7 minutes).
- 09** Relay card output is activated if remote control is connected and the DHW programming mode is enable (request).
- 10** For each DHW request, the relay output is activated
- 11** Not used.
- 12** Not used.
- 13** For each Cool request, the relay output is activated.(if the cool function is enabled).
- 14** As 01 included pump circulation
- 15** As 02 included pump circulation

3.2 CN2 RELAY CARD CONNECTOR (Programmable input-parameter P07)

Relay card **CN2** connector is an auxiliary input which can be set with parameter **P07** as follows:

- 00** = not used
- 01** = not used
- 02** = not used
- 03** = CH request enabled (e.g. trigger phone)
- 04** = Low temperature safety thermostat (e.g. floor heating system)
- 05** = DHW pump activation

3.3 Programmable input-parameter P06

When a sensor probe is connected, parameter **P06** has to be set as follows:

00 = external temperature has influence to calculate the heating flow temperature(see Kt curves);

01 = external temperature has no influence, display show the external temperature value.

Note: the external probe sensor and the wiring connection are supplied as accessories.

Without external probe sensor the input can be programmable as follows:

02 = not used

03 = CH request enabled (e.g. trigger phone)

04 = Low temperature safety thermostat (e.g. floor heating system)

05 = DHW pump activation

20..25 = enable RF external sensor with RU

25..30 = enable RF external

3.4 P06 and P07 -PARAMETER SETTING DESCRIPTION

- | | |
|-----------|---|
| 02 | Not used |
| 03 | This input enable the CH request (e.g. trigger phone) only if the Room Thermostat (RT) requiring heat.
Note: <u>be sure the heating mode is enabled (winter or only heating mode)</u> |
| 04 | This is an input contact for a Low Temperature Thermostat (e.g. floor heating system).
When the Low Temperature Thermostat cuts out, the display shows E178 anomaly and the burner switch off.
Note: <u>be sure the heating mode is enabled (winter or only heating mode)</u> |
| 05 | This input enable an external DHW recirculation pump to operates. To enable the input is necessary to set parameter P04 or P05 = 08 and P69 = 05 .
The pump will run at P19 minutes (CH and DHW mode or only CH mode) or P19/2 minutes (only DHW mode). |

4. Calibration function

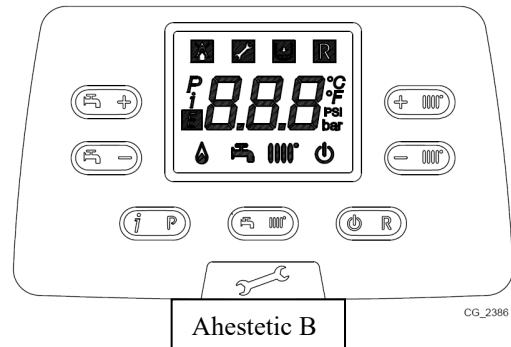
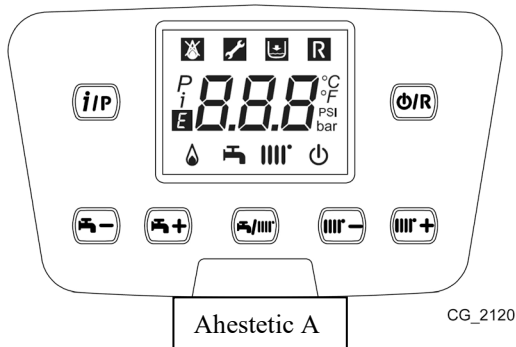

Ensure the maximum heat exchange to the system in Heating or DHW mode (DHW request) in order to avoid the boiler shutoff for overheating.

The function is made up of an automatic sequence and a manual sequence.

Automatic sequence

- Press together for about 6 seconds the and and within 3 seconds the button (after 6 seconds it is possible to heard a 'click' of the gas valve and see 'On' on the display);
- The function is active if the and blink together;
- After the ignition (also more than one attempt) the boiler works at the maximum power at least 1 minute then at the ignition power and at the end at the minimum. When the display shows *P* and icons means that the value of the curve has been stored. During the function the display shows the power level and the flow temperature alternatively.
- The end of the automatic phase has the icons that blink together.
- To esc from the function press the button.

Manual sequence

- ~~During the manual sequence the display shows the power of the boiler and the adjustment CO2 value.~~
- ~~To adjust the CO2 value at the different power press the or buttons; to increase the CO2 value press the button, to decrease the CO2 value press the button.~~
- ~~Finished to set the first point (minimum power) it is possible to pass at the set of the second point (ignition);~~
- ~~Press the button, the display shows the flow temperature and the power level;~~
- ~~Press the button to pass at the ignition power;~~
- ~~Press button to adjust the CO2 value;~~
- ~~Proceed in the same way for the maximum power.~~

The function lasts 30 minutes from the last pressure of a button or it is possible to cut off pressing the button.

----- IMPORTANT NOTE -----

5. PCB spare

(without easy service memory stick)

The procedure is the following:

- Switch off the boiler and make sure the power supply is cut out
- Remove the frontal panel and open the plastic box
- Pull the memory stick out of the pcb and move it in the new one
- **Pay attention to insert the memory stick in the right position on the connector (see the shape printed on the pcb and match the corners);**
- Replace the pcb
- Close the plastic box and place the frontal panel to close the boiler
- Switch on the boiler (power supply)
-

NO PARAMETERS CHANGE ARE NEEDED

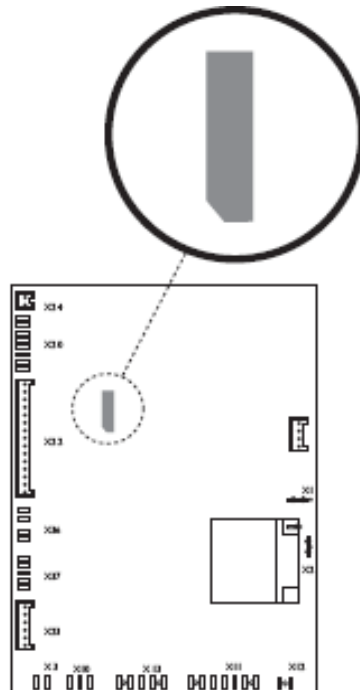
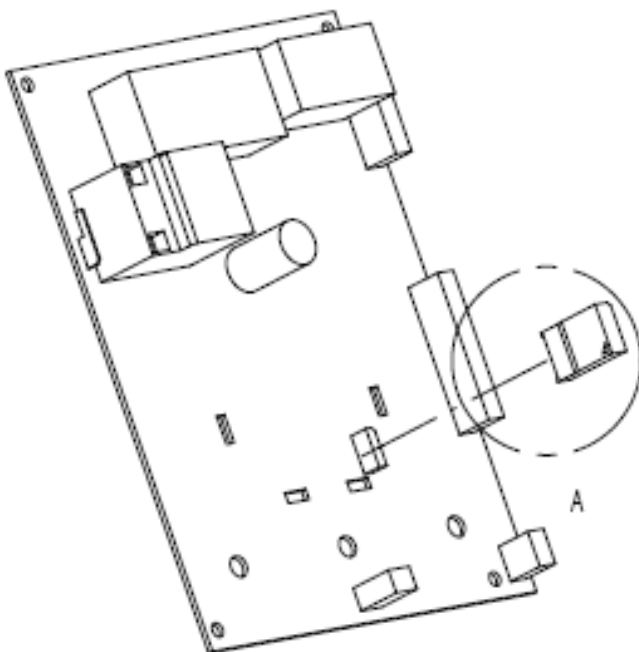















6. PCB Spare with easy key service

The procedure is the following:









- Switch off the boiler and make sure the power supply is cut out
- Remove the frontal panel and open the plastic box
- Replace the easy key
- Close the plastic box and place the frontal panel to close the boiler
- Switch on the boiler (power supply)

If the display shows **E135** press the  button for about 2 seconds. The first message that the display shows is **E55 or E53** (not calibrated/setting pcb); proceed as following before calibrated the boiler.

PCB Configuration (only Ahesthetic B) :

- 1) Press together for about 6 seconds the  and  buttons, the display shows **P01** alternating with its value;
- 2) Press the  and  buttons to scroll the parameters list until parameter **P22**;
- 3) Press  button to edit the selected parameter (parameter blinks); press  and  buttons to modify the parameter value; set **P22 = 22**;
- 4) Press  button to save the parameter value;
- 5) Press the  and  buttons to scroll the parameters list until parameter **P76**;
- 6) Press  button to edit the selected parameter (parameter blinks); press  and  buttons to modify the parameter value; set **P76 = 01**;
- 7) Press  button to save the parameter value;
- 8) Press  button to esc and continue at next point.

PCB Configuration (for other aesthetic):

- 9) Press together for about 6 seconds the  and  buttons, the display shows **P01** alternating with its value;
- 10) Press the  and  buttons to scroll the parameters list;
- 11) Press the  button to edit the selected parameter (parameter blinks);
- 12) Press the  and  buttons to modify the parameter value;
- 13) Press the  button to save the parameter value;
- 14) After the setting press the  button to exit.

Check the following parameters:

Table1

P02	Gas type
0	Natural gas
1	LPG

Table 2

P03	Hydraulic System
0	Istantaneous combi
1	Micro tank on CH (MAX)
3	Istantaneous preheat (3 stelle)
5	External tank
6	Integrated tank
8	CH only
10	solar
10	Hybrid (heat pump, solar,..)

Table 3

P09	Hydraulic block
0	Composite
1	Brass

In the default condition it is possible to scroll the parameters until **P42**. If you need to set some parameters after **P42** proceed in the following way:



- Set **P22 = 22**;
- Press the  button to save the parameter value;
- Press the  and  buttons to scroll the parameters from P42 to last parameter.

Table 4

P25	Lack of water safety device
0	Water Pressure Switch
1	Water Flow Switch
2 (compact version)	Water pressure switch on/off

Table 5 (only for Hybrid system)

P45 = 00	Forced CH request
P67 = 02	OT selection

Table 6

P73	Power (kW) (Central heating – Domestic Hot water)	P13 (%Central Heating)	P14 (%Domestic Hot water)
0	20/24 (SS) from cod 722017606 20/24 (SS) da matricola 173604081 a 173604104 da matricola 174203071 a 174203091 da matricola 174299003 a 174299005	80	100
0	20/20 (SS) from cod 722017508	80	80
1	24/28	86	100
2	28/33	80	100
3	32/40	74	100
4	12	100	100
5	15	100	100
6	18	100	100
7	20/24 (SS) until 722017605	80	100
7	20/20 (SS) until cod 722017507	80	80
9	28	100	100
10	32	100	100
11	24	100	100
19	12/16	77	100
7	20/20	80	80
22	24/29	82	100





After the setting of the boiler is it possible to proceed with the calibration function.





The verify of the CO2 level must be done with a calibrated combustion analyzer.

7.CO2 adjustment

(to enable in case of the CO2 value is out of range as describe on the literature).

To enable the function follow the sequence:

- press together for about 6 seconds the  and .
- when the function is active the display shows 'On' (2 seconds) and the code **304** with the power of the boiler in %;
- after the switch on of the burner the boiler goes at maximum power in DHW (100);
- to adjust the CO2 level press the  button;
- the display shows '00' and the code 304 (the flame symbol blinks);
- press  and  to increase or decrease the CO2 value (from +5 to – 5);

- g) press  button to store the new value; the display will show again 100;
- h) for the ignition power press  button and follow from the point d); same procedure for the minimum power;
- i) to esc from the function press together for about 6 seconds the  and .

8. General spares

If a new:

- Exchanger
- gas valve
- gas nozzle
- fan
- Burner
- Ionization electrode

the **Automatic sequence of the Calibration function** is needed. After that check the combustion and adjust the CO2 value with the CO2 adjustment function.



NOTE: It is recommended, whenever you perform an operation, to check the integrity of the sensing electrode; in case of deterioration, replace it.

9. Manual Control function (301)

It is possible to enable a special function 301 that permits to work the boiler at a fixed set point.

By pressing both  and  buttons together for 6 seconds the display will show 'On' and '301'.

By pressing  and  it is possible to change the set point of the boiler step by step (1°C) from maximum to minimum.

The function lasts 30 minutes from the last pressure of a button or it is possible to cut off pressing the  and  buttons at least 6 seconds.

10. Commissioning Function flow chart

To complete the function check:

- power supply (220v 50Hz + T – fuse)
- pressure gas (dynamic pressure @ max power: Natural gas- 22 mbar LPG- 37 mbar)
- heat exchange (Central heating or domestic Hot Water)

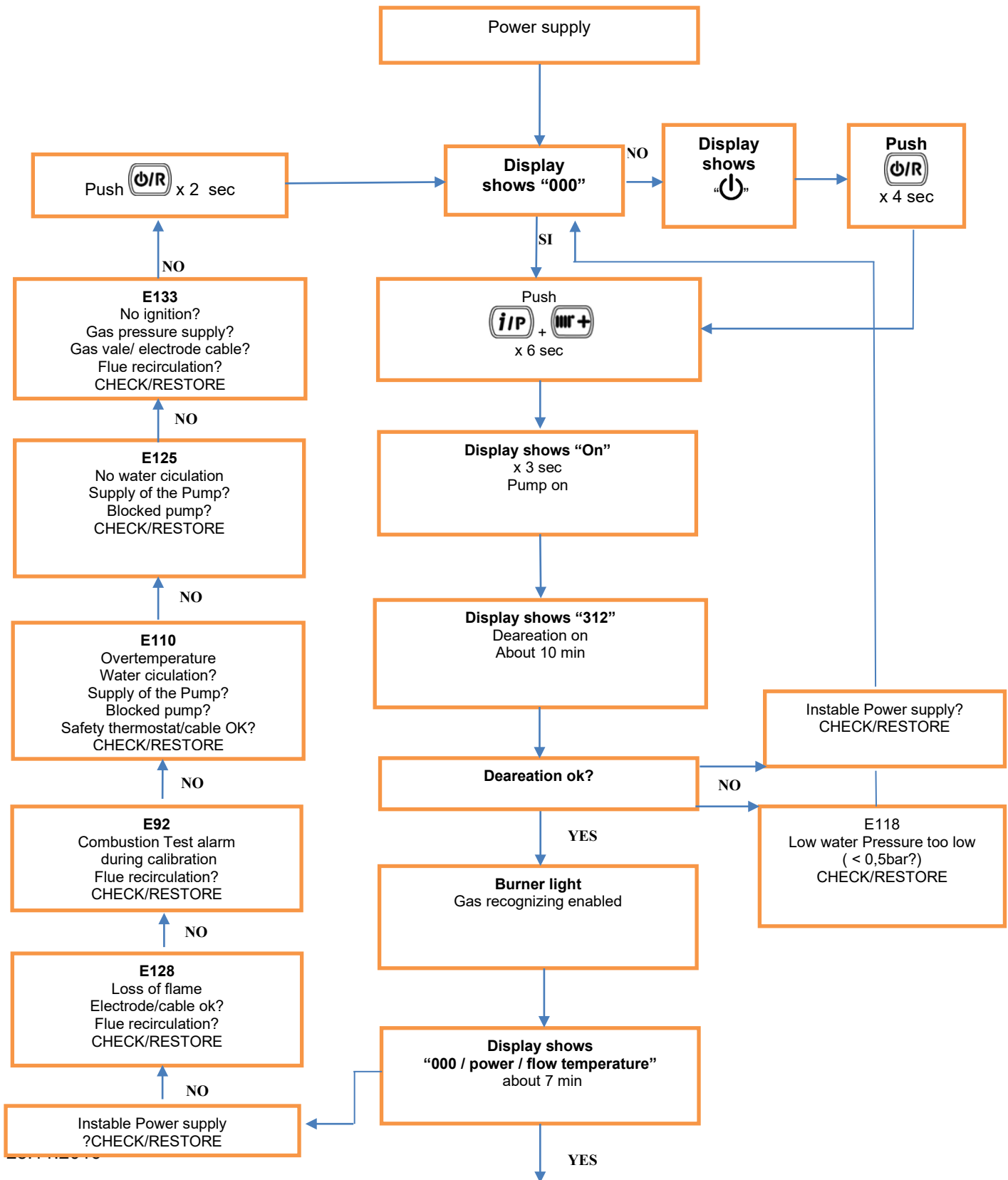

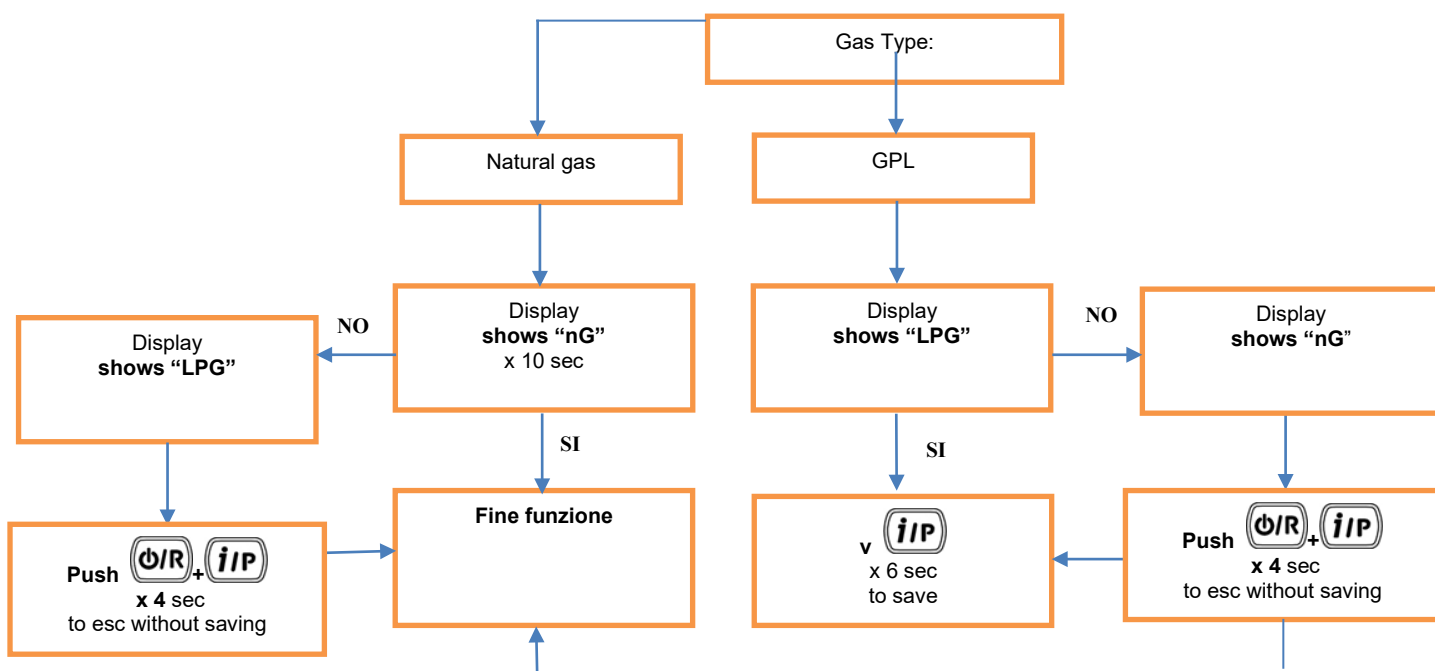

In the case of continues E92/E133 during the commissioning, it is possible to enable a Recovery function (Mini Calibration ignition). The Recovery function is activated as a function of Calibration (Chapter 4) and ends automatically when the system finds the correct level of ignition.

As for the calibration function it is possible to have more attempts to ignition.

In case of Commissioning function doesn't work again it is possible to disable.

For sw version <= 2.00

Set P22 = 22 as described in Chapter 1 and set P75 = 100, confirm with INFO button then cut power to the boiler.

In the plant where there is no possibility of an adequate heat exchange (sites in the summer with under floor heating) disable the Commissioning function ONLY after finishing the Deareation and ONLY after verifying the non-recognition capabilities of the gas (max temperature is reached) .

The P75 parameter could be set in different way (different markets):

- 25 = Gas Ricognizing
- 50 = Complete Commissioning (Deareation and Gas Recognizing)
- 75 = Deareation
- 100 = No Commissioning

For sw version >= 2.20

It is possible to skip the single function (deareation, Gas recognizing or complete Commissioning) pushing **iP button at least 6 seconds**.

11. Pressure table

Power	P73	Gas type	P Mix [Pascal] ± 10%
12 kW	4	G 20	760
		G 31	700
15 kW	5	G 20	650
		G 31	620
18 kW	6	G 20	560
		G 31	560
24 kW	11	G 20	550
		G 31	600
12/16 kW	19	G 20	800
		G 31	700
20/20 kW	7/0	G 20	500
		G 31	500/550
20/24 kW	7/0	G 20	550
		G 31	550/600
24/28 kW	1	G 20	780
		G 31	850
28 kW	9	G 20	730
		G 31	750
28/33 kW	2	G 20	820
		G 31	890
32 kW	10	G 20	400
		G 31	400
24/29 kW	22	G 20	790
		G 31	860
32/40 kW	3	G 20	630
		G 31	690

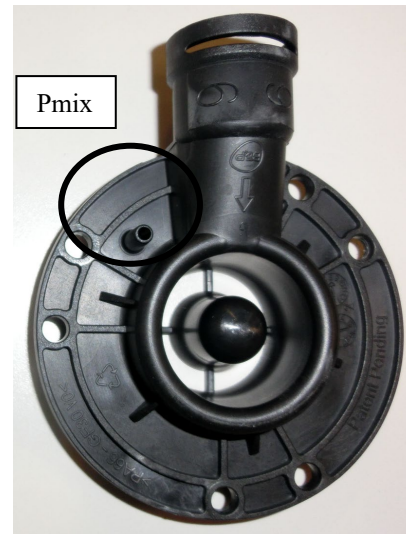

The value of Pmix is tested with:

- 1 m of flue duct (coaxial and separated)
- at max heat input (DHW power)
- door on
- <1000m m.s.l.

These values are indicative, it is necessary to consider the tolerances of the components (i.e. the fan), the length of the flue duct and the calibration of the manometer. The measurement is used to understand if there is an obstruction in the system or in the exchanger.

Example:

Boiler 24/28kW (P73=1) with G20 →780Pa

If Pmix measured = 580 Pa:

$$\sqrt{(580/780)} * 100 = 86\%$$

This means that with 580Pa measured the power of the boiler is at 86% (not 100%).

In this case the derating of the boiler is from 28kW to 24kW.

12. Installation with flue duct Ø 50 mm

It is possible to have installations with flue duct Ø 50 mm for boilers with heat output 24kW.

- LUNA DUO-TEC 24
- LUNA DUO-TEC 1.24
- LUNA DUO-TEC IN 24
- LUNA DUO-TEC IN 1.24
- LUNA DUO-TEC MAX 24
- NUVOLA DUO-TEC 24

Depending on the length of flue duct is necessary to change the parameter P71 as described in Table:

Length Ø 50 mm	P71 Parameter value
$0 < L < 10$ m	100 (default)
$10 < L < 20$ m	130
$20 < L < 30$ m	160

It is necessary to perform the automatic calibration function as described in the section 4 after changing P71.

NOTE:

- The pressure drop of a elbow 90° is 4 m.
- The pressure drop of a elbow 45° is 2 m.
- The pressure drop of the kit Ø 80/60 mm is not considered for the maximum length.
- The air inlet duct Ø 80 mm could be max 15 m (it is independent from the flue duct length).
- At the end of installation verify the correct operating of the condensate trap.

NOTE: When instructed press and hold the 'Reset' for between 1-3 seconds to reset the boiler.

Table Of Error Codes

E09	Gas valve connection cable
E10	External probe fault
E12	Water flow switch open
E13	Water flow switch close
E15	gas valve fault
E18	Water refill enabled
E19	Max time of water refill
E20	Central Heating Flow NTC Fault
E28	Flue NTC Fault
E40	Central Heating Return NTC Fault
E50	Hot Water NTC Fault (tank version)
E53	Obstruction on the flue pipe
E55	PCB to be set by the "Calibration Function"
E71	Fan parametr Out of range in autocalibration
E72	Combustion test Out of range in autocalibration
E77	Current out of range
E78	Minimum gas valve current
E79	Maximum gas valve current
E83-87	Communication error
E92	Combustion test alarm during auto-setting
E109	Pre-Circulation Fault
E110	Safety Thermostat Operated
E117	System Water Pressure Too High
E118	System Water Pressure Too Low
E125	Circulation Fault (Primary Circuit)
E128	Flame Failure
E129	Frequently loss of flame during the ignition
E130	Flue NTC Operated
E133	Interruption Of Gas Supply or Flame Failure
E134	Elapsed time Gas valve open without gas
E135	Gas valve connection cable /internal error
E160	Fan or Fan Wiring Fault
E321	Domestic Hot Water NTC sensor fault
E384	False flame
E385	Under voltage
E431	Aluminium sensor fault

Initial Fault Finding Checks

1. Check that gas, water and electrical supplies are available at the boiler.

2. Electrical supply = 230V ~ 50 Hz.

3. The preferred minimum gas pressure is 20 mbar for Natural gas and 37 mbar for LPG.

4. Carry out electrical system checks, i.e. Earth Continuity, Resistance to Earth, Short Circuit and Polarity with a suitable meter.

NOTE: These checks must be repeated after any servicing or fault finding.

5. Ensure all external controls are calling for heat and check all external and internal fuses. Before any servicing or replacement of parts, ensure the gas and electrical supplies are isolated.

1. If a fault occurs on the boiler an error code may be shown by the facia display.

E20, E28, E40, E50, E160, E321 and E431 indicate possible faulty components.

E53 shows possible obstruction in the flue duct.

E55 indicates that the pcb is not setting/calibrated.

E71, E72, E77, E78 e E92 indicate possible wrong calibration. A new calibration is needed. Check the supply gas pressure

E92 shows possible flue recirculation in the flue duct.

E83...87 shows possible error of communication with Room units (Goto section P)

E110 shows overheat of the primary.

E117 is displayed when the primary water pressure is more than 2.7 bar.

E118 is displayed when the primary water pressure is less than 0.5 bar.

E125 is displayed in either of two situations:-

i) If within a time between 15..30 seconds of the burner lighting the boiler temperature has not changed by 1°C.

ii) If within 10 minutes of the burner lighting the boiler temperature twice exceeds the selected temperature by 30°C. In these instances poor primary circulation is indicated.

E128 is displayed if there has been a flame failure during normal burner operation.

E133, E134 and E135 indicate that the gas supply has been interrupted, ignition has failed or the flame has not been detected.

2. By pressing the 'Reset' button for between 1-3 seconds when E110, E125, E133, E134, E135, E09, E15, E128 and E384 are displayed it is possible to relight the boiler.

3. If this does not have any effect, or error codes are displayed regularly further investigation is required.

Central Heating

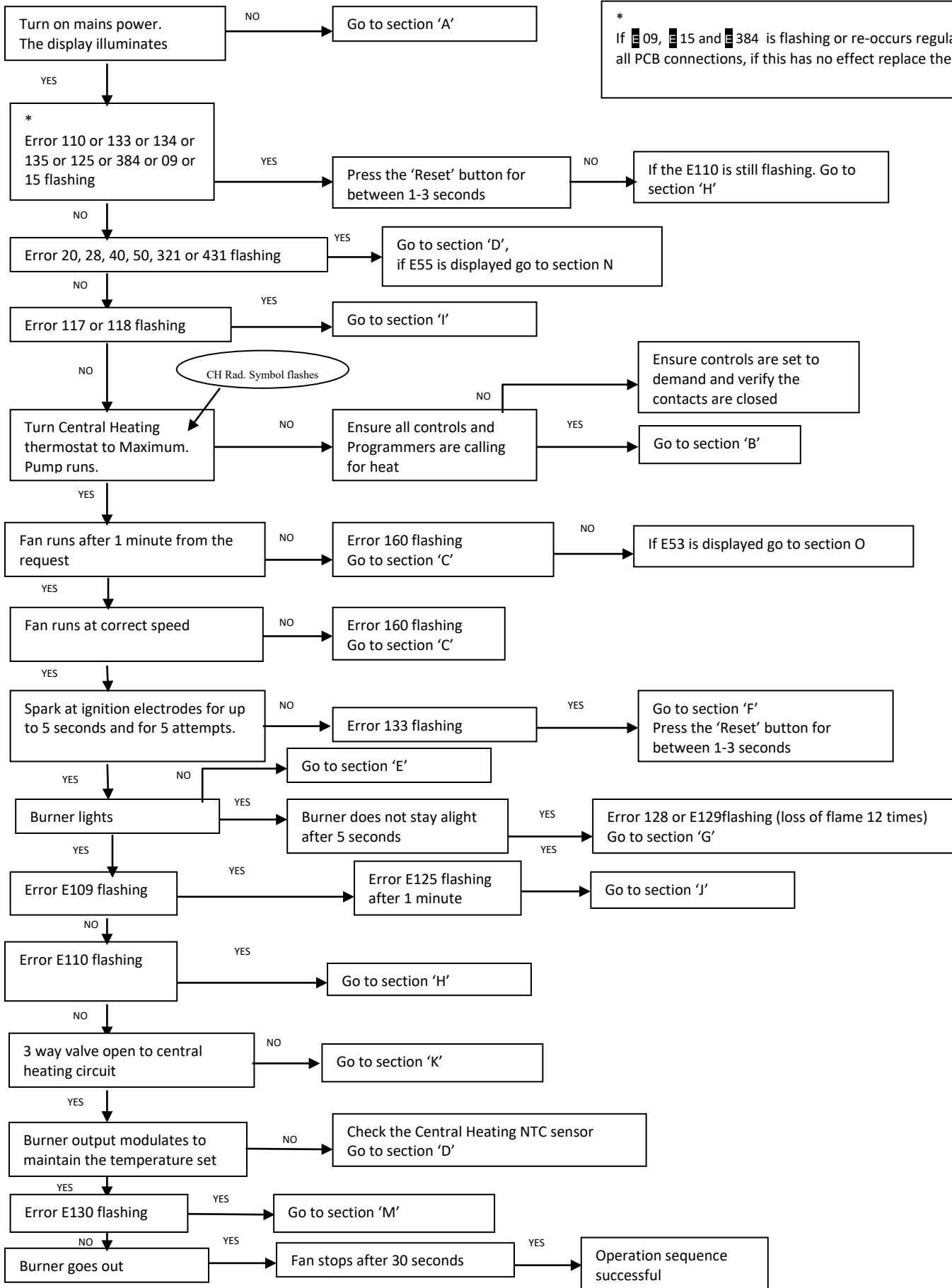

Domestic hot water

*
If E09, E15 and E384 is flashing or re-occurs regularly check all PCB connections, if this has no effect replace the PCB.

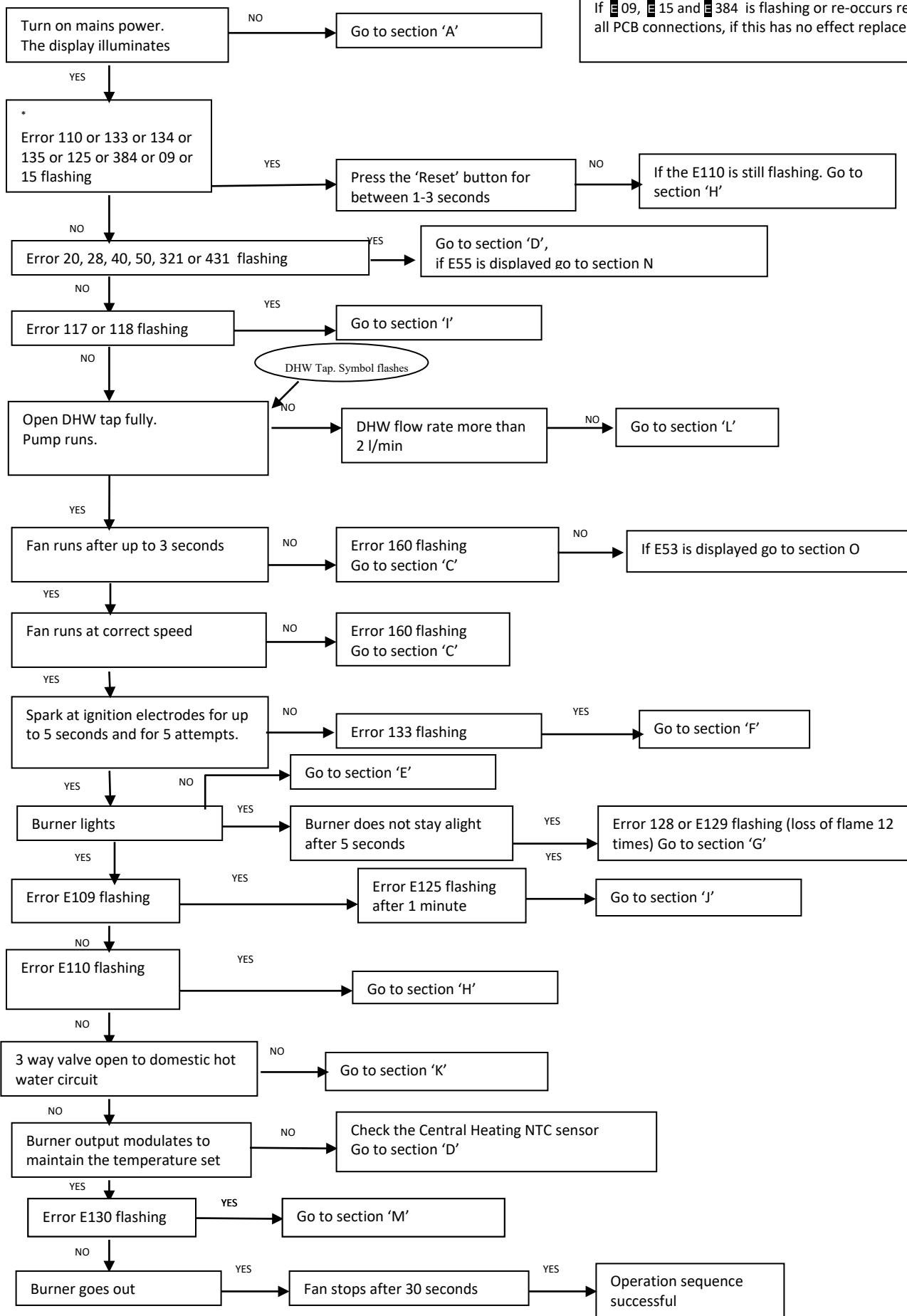

Fault Finding Solutions Sections

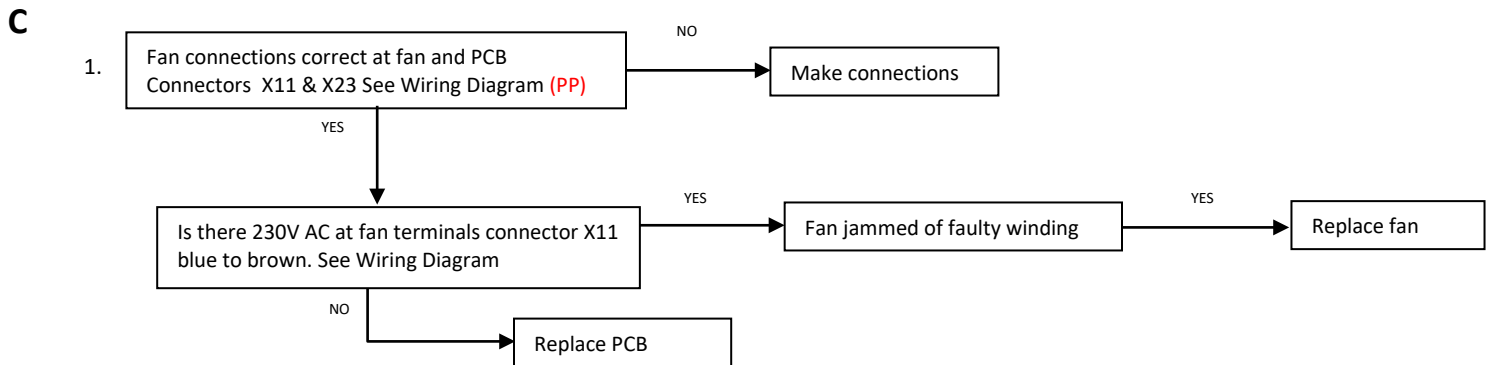
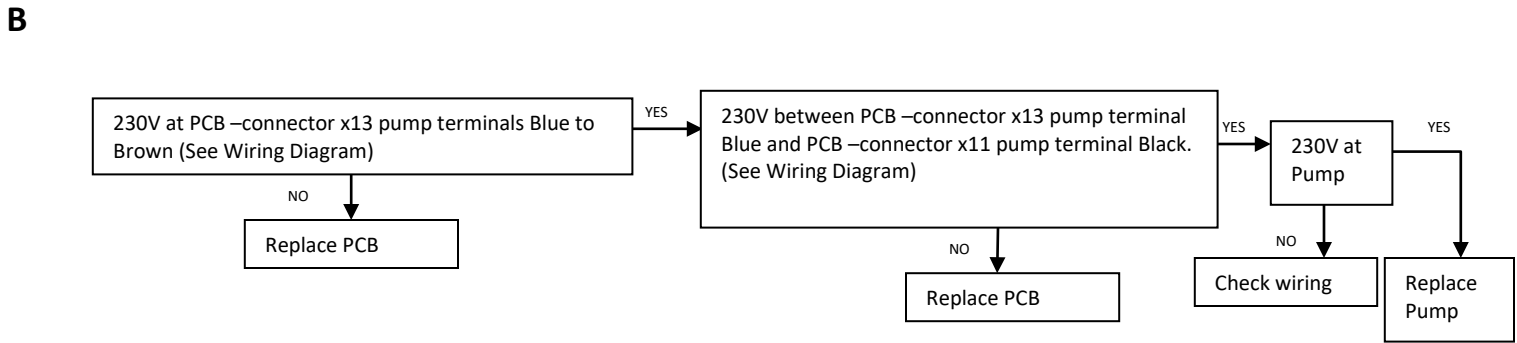
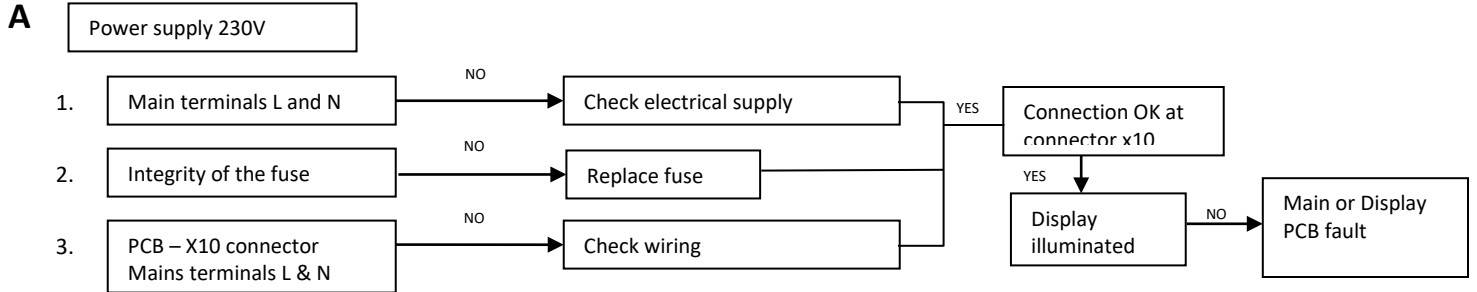

D

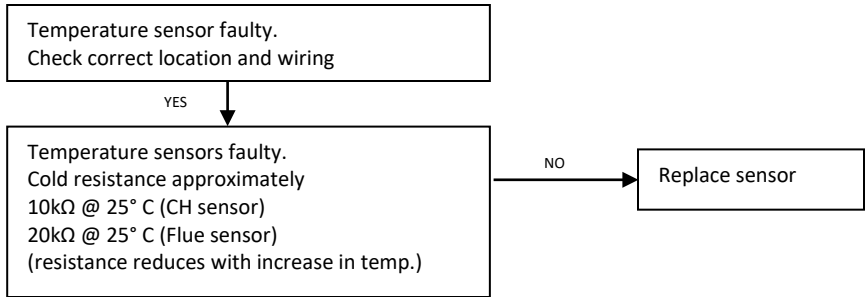

E

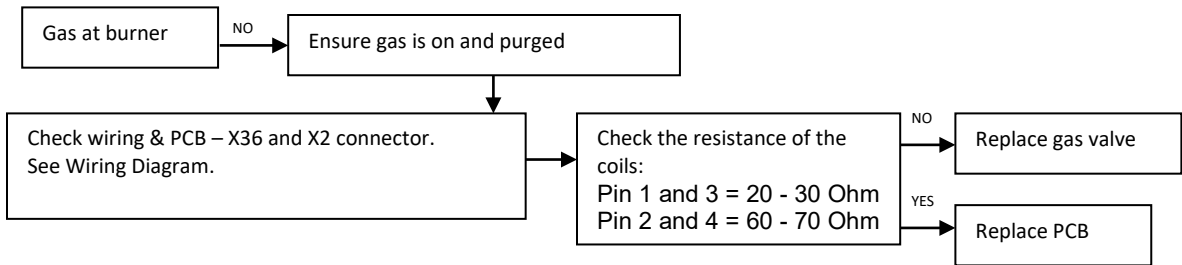

F

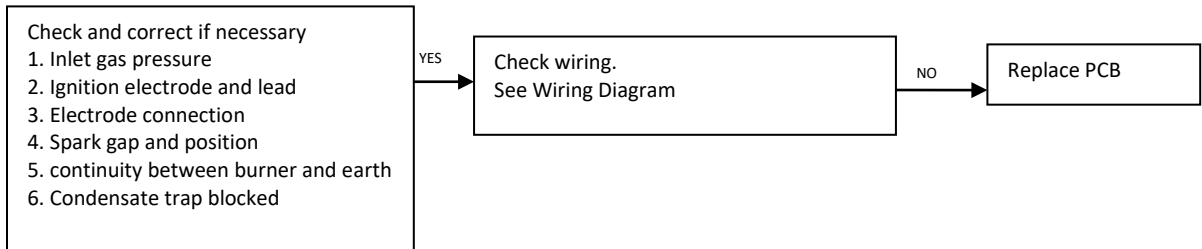

G

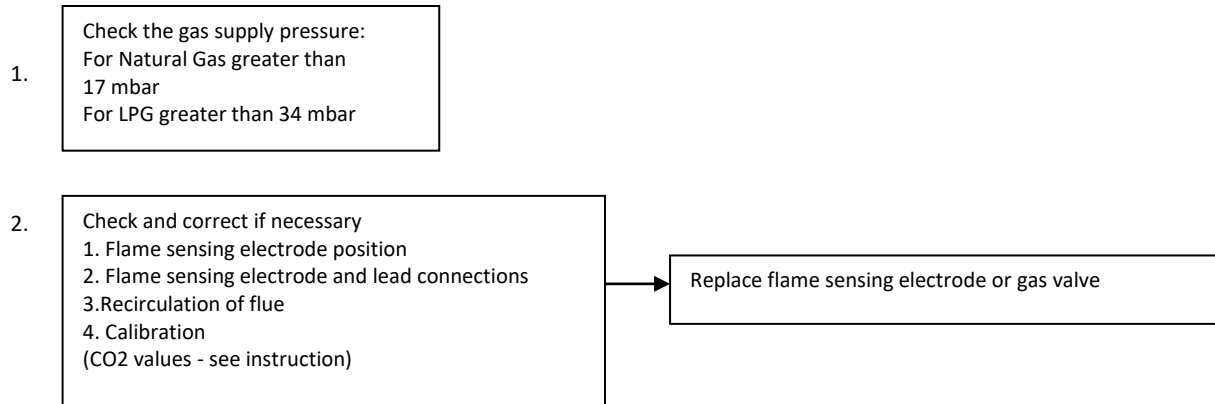

H

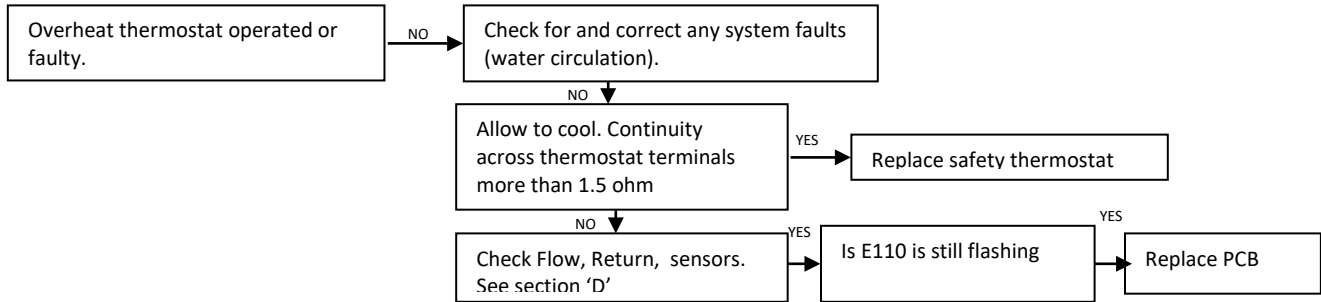

I

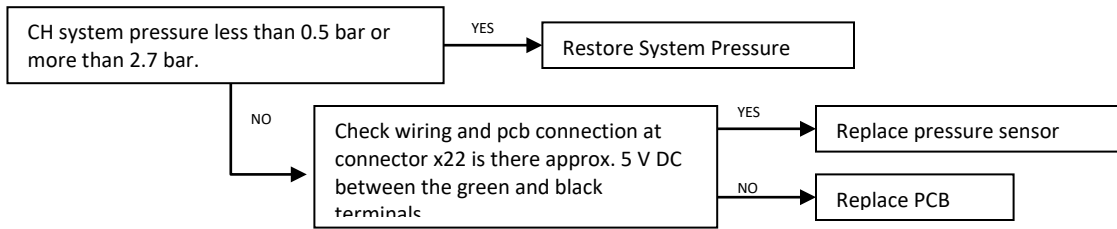

J

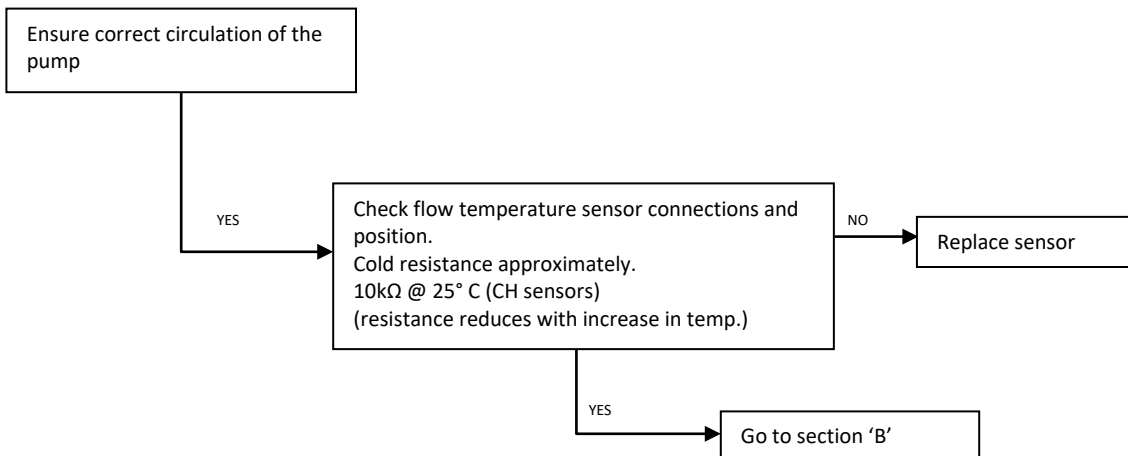

K

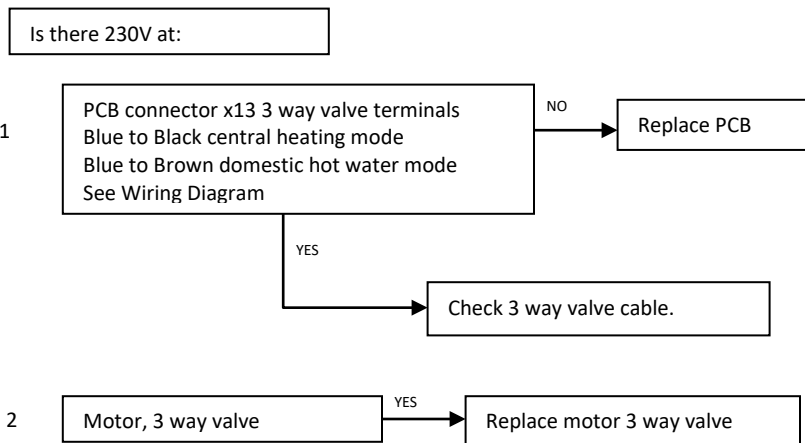

L

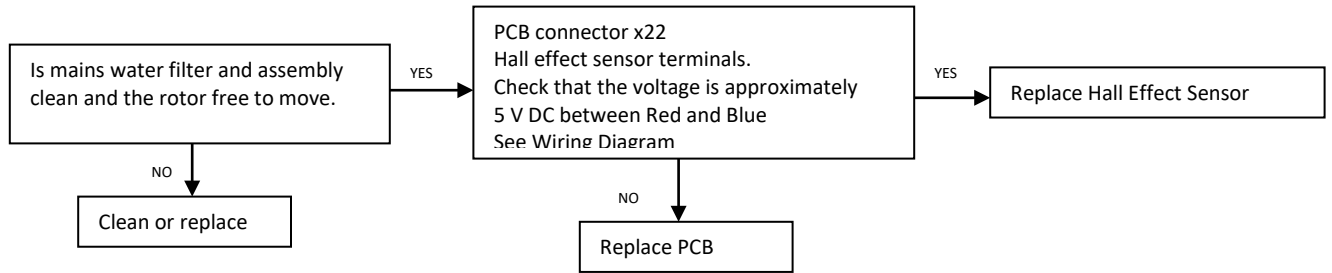

M

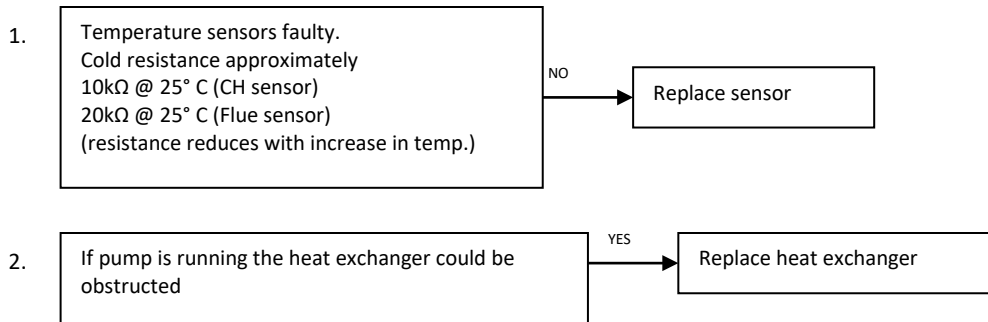

N

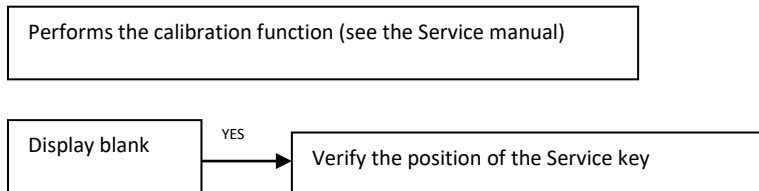

O

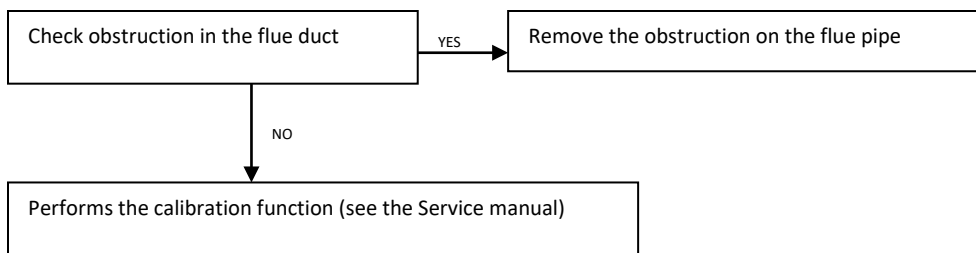

P

