

N° 2 AGGANCI CALDAIA COD. 51.1108.1
 DA FISSARE CON N° 4 RIVETTI A STRAPPO COD. 830.026.2

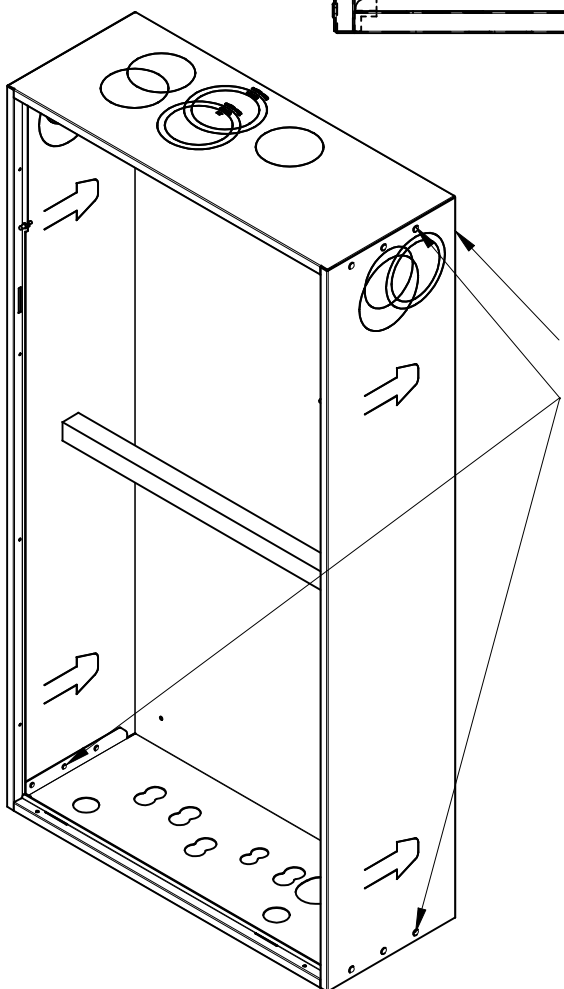

A →

PERNO M4 COD. 51.0220.1
 N. 2 PEZZI
 DADO M4 COD. 821.230.3
 N. 2 PEZZI

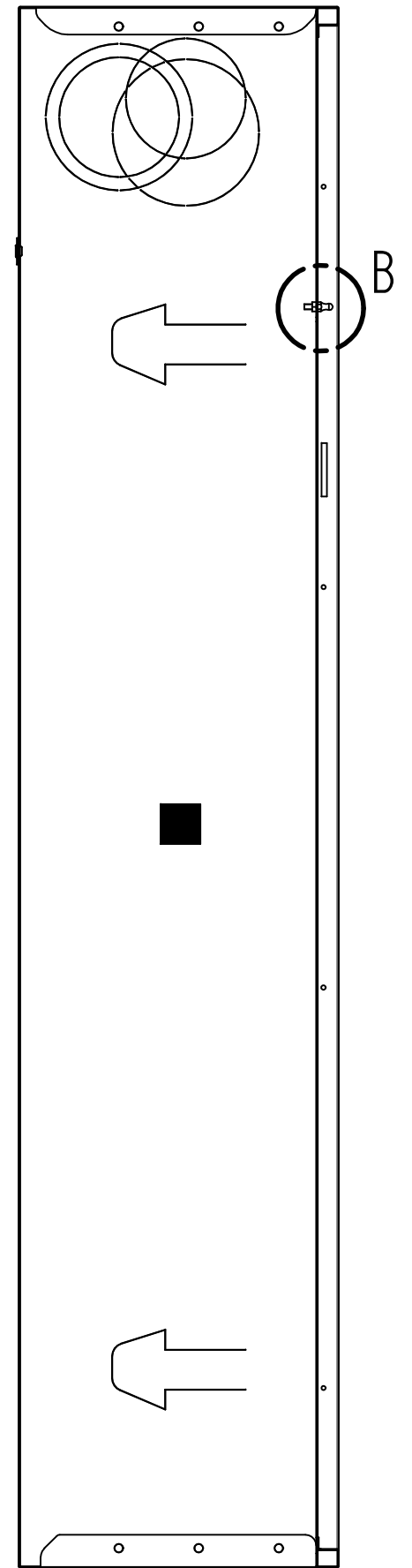
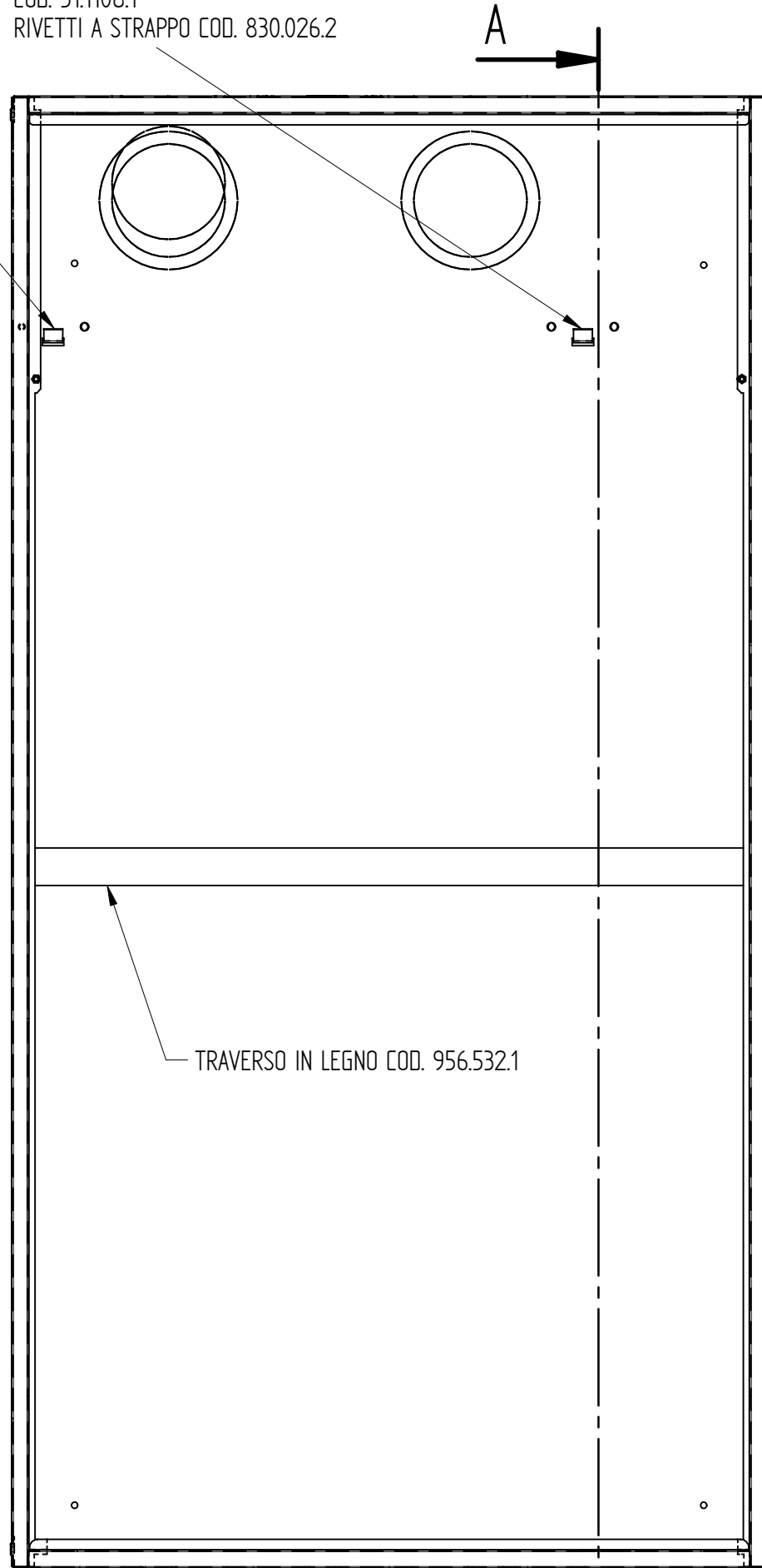
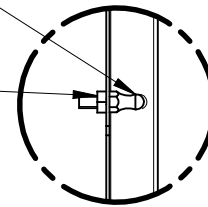

DETTAGLIO B

INVOLUCRO CASSA COD. 51.1721.1
 N° 12 RIVETTI A STRAPPO COD. 830.026.2

ASS. INVOL CASSA IN - IN HT						
DENOMINAZIONE	N°	Peso	design.	Materiale	codice	Stato
						Disegnato Pedron
						Data 04-05-07
						Controllato Scala
						1 : 10
						Sostituisce il
						Derivato dal
						Specifica
						MOD.
						CASSA LUNA IN - IN HT
POS			Firma	Richied.	Data	
BAXI S.p.A.			Emittente DIRS		CODICE	
			Coimpiegante		569075	

DISEGNO ESEGUITO CON CAD - NON CORREGGERE O MODIFICARE A MANO

FORMATO A3 - UNI 936

Conforme Direttiva:
 ROHS 2002/95/CE

BAXI S.p.A. si riserva a termini di legge la proprietà
 del presente disegno con divieto di riprodurlo o
 comunicarlo senza la propria autorizzazione.

Classificazione delle caratteristiche

C = Critica
 I = Importante

Classe

1 2 3

Tolleranze generali

UNI ISO 2768-mK

ALL COMPONENTS MUST COMPLY WITH THE EUROPEAN DIRECTIVE ON THE RESTRICTION OF THE USE OF THE CERTAIN HAZARDOUS SUBSTANCES (RoHS)
CHECK REVISION AND STATUS BEFORE USE

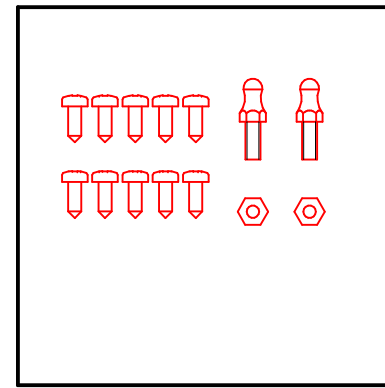
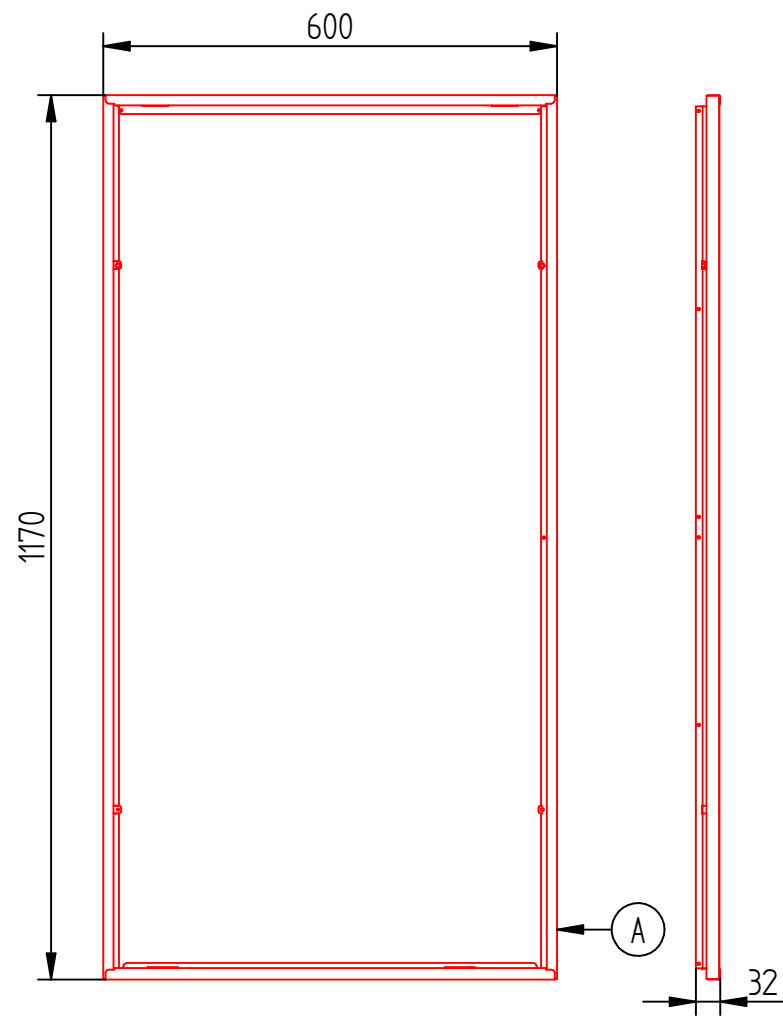

SCALA 1:2

(*)
B

- (*) The bag assembly is formed by :
- n°10 Screws 3.5x9.5 self-threading code 72 24147
 - n°2 pins M4 code 51.0220.
 - n°2 nuts M4 A Np6.S-ZN7III code 821.230.3
 - n°1 bag 100x100 code 7101137
 - n°2 steples 648 galvanized code 7101134

722501601

KIT CORNICE

FRAME KIT

D

codice a barre tipo C128
vedi 7224051.....

722501601

codice a barre tipo EAN13

8022945308760

- Label size defined by supplier
- Characters and graphics shown are indicative
- Thermic transfer print
- Print with black colour.

PRELIMINARY

CODE BAXI PACKED
722501601

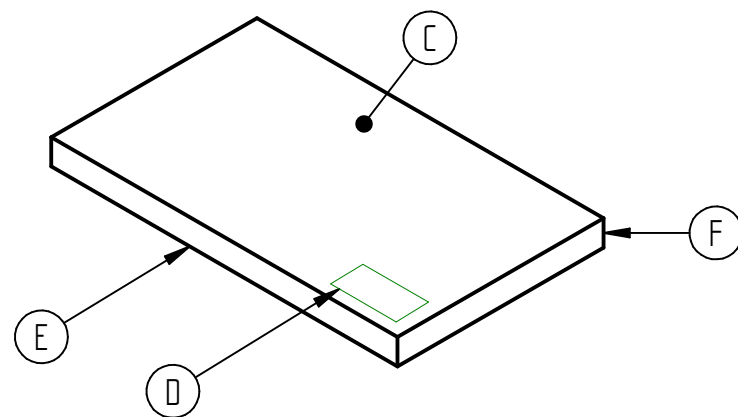

POS.	DESCRIPTION	Q.TY	BAXI CODE
F	Copper point 35/18 (3/4)	8	-
E	Packing box 35x1175x605	1	-
D	Identification label kit 7225016	1	-
C	Frame kit - Instruction sheet mounting	1	7225044
B	Bag with screw,pins,nuts.	1	7225085
A	Frame assembly	1	7223088

Change Description			Refers To
DIMENSION TOLERANCE TO ISO 14405	QUALITY SIGNIFICANCE: [C] DENOTES A CRITICAL DIMENSION. DEVIATION FROM THE SPECIFICATION MAY COMPROMISE THE SAFETY AND/OR THE FUNCTIONALITY OF THE FINISHED PRODUCT.	Tolerance:	
A3	Sheet No.: 1 of 1	First Angle Projection	Material Specification:
Units: mm	Scale: -		Creator: Pedron, Aurelio
		Date Of Issue: 22/07/2015	
		Title: FRAME KIT	
Release Status: Production		Work In Progress When Blank	Item Number: 7225016
			Revision: 01

THE REPRODUCTION, DISTRIBUTION AND UTILIZATION OF THIS DOCUMENT AS WELL AS THE COMMUNICATION OF ITS CONTENTS TO OTHERS WITHOUT EXPRESS AUTHORIZATION IS PROHIBITED. OFFENDERS WILL BE HELD LIABLE FOR THE PAYMENT OF DAMAGE.
ALL RIGHTS RESERVED IN THE EVENT OF THE GRANT OF A PATENT, UTILITY MODEL OR DESIGN.